



Single Family Residential Erosion/Sediment Control Standards

Building & Planning Departments
City of Basehor, KS

Introduction

This booklet contains standard plans and procedures sufficient for typical residential building construction, it is not intended to address all circumstances. The primary objective is perimeter control with best management practices (BMP's) being utilized to prevent erosion and minimize sediment from leaving the site. Additionally, since Overland Park streets are conduits for storm water, it is important to keep mud and sediment off the streets. The building permit holder is responsible for ensuring that adequate BMP's are in place and functioning until the construction project is brought to a close.

There will be situations where lot to lot protection may not be required. For example, two houses under construction on adjacent lots with surface drainage running front to back. Given this scenario, it is not the intent of this booklet to require perimeter control between the two construction sites. However, should one project be completed prior to the other, BMP's may be required.

When reviewing this standard against your construction project, always keep in mind the intent of the standard; and that is "to prevent erosion and minimize sediment from leaving the site." Failure to do so can result in damage to adjacent property, damage to the city's storm sewer system, and contribute to the polluting of streams, lakes and rivers. If any questions or concerns arise, please feel free to contact me or one of my staff. We are committed to helping all of those involved with the implementation of these construction procedures.

SINGLE FAMILY RESIDENTIAL

EROSION AND SEDIMENT CONTROL STANDARDS

Table of Contents

	<u>Page</u>
BMP Installation Sequencing	1
Contractor Responsibilities	2
Inspections - City	3
Single Family Lot Erosion Control Plan - Type A	4
Single Family Lot Erosion Control Plan - Type B	5
Single Family Lot Erosion Control Plan - Type C	6
Curb Inlet Protection - Gravel Filter Bag	7
Area Inlet	8
Temporary Construction Entrance	9
Sediment Fence	10
Fence Installation	11-13

BEST MANAGEMENT PRACTICES

BMP's - Examples include but are not limited to sediment fence, straw mat, seed and mulch.

Installation Sequencing

- 1) **Inlet Protection** - Ensure that the BMP's are in place and functioning for both area inlets and curb inlets along the street frontage.

- 2) **Protection of Adjacent Lots** - Install BMP's along the common lot line of adjacent sodded or seeded lots.

- 3) **Grading/Excavating** - Install all BMP's prior to any grading or excavating activities, where practical.

- 4) **Stabilize Stockpiles** - Install BMP's to stabilize stockpiles to prevent sediment from reaching the street.

- 5) **Backfill** - Complete installation of all BMP's per the specified design, i.e., type A, B, C or per other engineered design.

- 6) **Temporary Construction Entrance** - Required (see detail).

- 7) **Maintenance** - The builder is responsible for maintaining and repairing all BMP's as needed throughout construction.

- 8) **Final Grading** - BMP's may be removed in order to complete final grading and sodding of lot. If sodding of the lot is delayed, the contractor is required to maintain BMP's until the sod can be put down.

CONTRACTOR RESPONSIBILITIES

- 1) The permit holder is responsible for the on-going maintenance of all lot specific erosion and sediment control devices.
- 2) Periodic inspection shall be whatever is deemed necessary to ensure that erosion and sediment control measures are functioning as designed. In addition to standard periodic inspections, city ordinance requires that an inspection be conducted after each rain event of 1/2" or more in a 24-hour period. Any problems noted during these inspections shall be corrected immediately.
- 3) Once construction has commenced, the permit holder is responsible for the maintenance of erosion and sediment control measures protecting area inlets on their lots, as well as curb inlets along the street frontage. It is critical that sediment not be allowed to invade the storm sewer system.
- 4) The temporary construction entrance provides a place for parking vehicles off-street and a spot where material can be off-loaded. The intent of the requirement is to provide a stable surface for parking vehicles where mud and other debris is not likely to be tracked onto the street. Proper maintenance of the area is required until such time as a permanent driveway can be put in place.
- 5) **During the entire construction process the permit holder is responsible to ensure that mud, dirt, rocks and other debris are not allowed to erode onto city streets and sidewalks, nor tracked onto the streets by construction vehicles.** Should any mud or other debris find its' way to the street, the contractor shall take immediate steps to have it removed.

Maintenance (sediment fence)

- 1) Inspect sediment fences at least once a week and after each 1/2" or greater rainfall. Make needed repairs immediately.
- 2) Should the fabric of the sediment fence collapse, tear, decompose or become ineffective, replace promptly.
- 3) Remove the sediment deposits as necessary to provide adequate storage volume for the next rain and to reduce pressure on the fence. Take care to avoid damaging or undermining the fence during cleanout.
- 4) If the utilities are installed after BMP's have been put in place, the permit holder is responsible for control of erosion and sediment during the construction process and they are responsible to ensure that all BMP devices are reinstalled per the original design.

INSPECTIONS – CITY

- 1)** City inspectors will normally inspect erosion and sediment control measures in conjunction with routine inspections. Inspections will ensure that proper placement and installation of erosion and sediment control measures are in place.

- 2)** The first inspection will occur at the time of the footing inspection. As noted in the general sequencing notes, standard items to be checked are: protection of adjacent lots, grading/excavating, and that stockpiles are stabilized. If BMP's are not installed in the correct location and/or not installed correctly, the inspection may be denied.



- 3)** It is anticipated that by the time the plumbing ground rough inspection is requested, backfilling of the foundation will have been complete and all erosion and sediment control measures will have been installed. If the permit holder fails to install the proper erosion and sediment control measure, this may result in the inspection being denied.

- 4)** There will be situations that fall outside of the norms. City inspectors will be available to discuss erosion and sediment control measures for any lot and the sequencing for installation. If you have questions or concerns call your inspector or call (913)895-6248 and speak with the Inspection Supervisor.

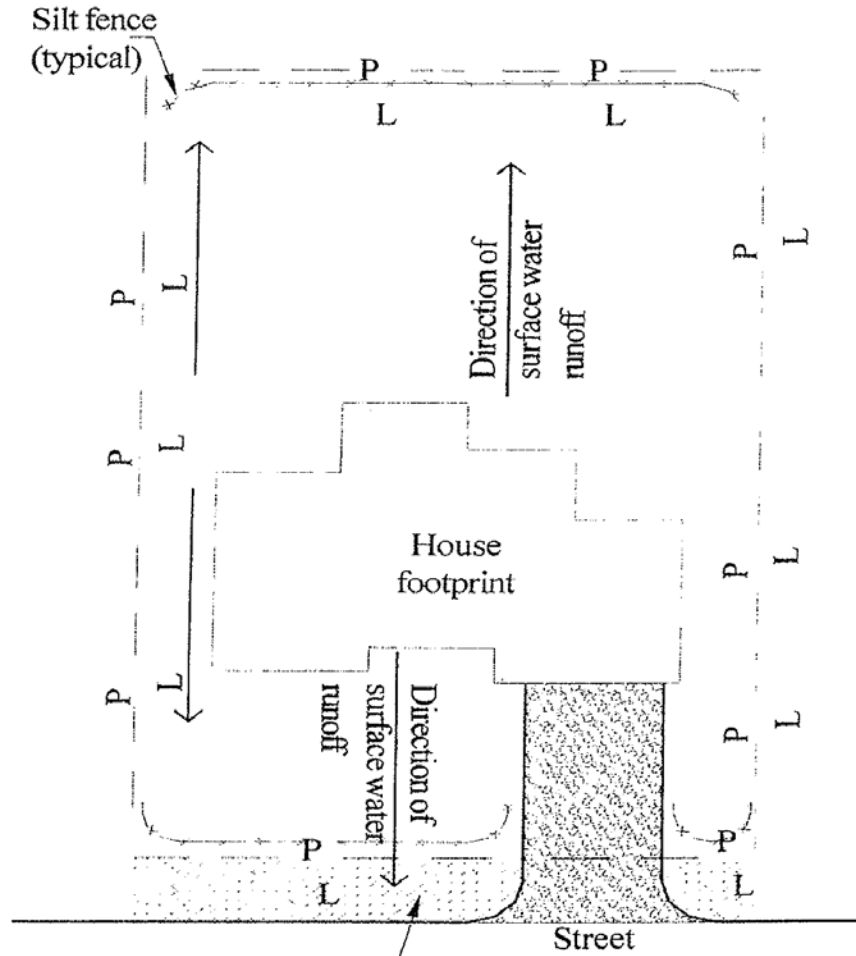
Single Family Lot Erosion Control Plan - Type A

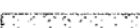

An erosion control mat will be placed on the entire ROW (optional)

-  Silt fence
-  Gravel construction entrance
-  Direction of surface water runoff
-  Erosion control mat

Single Family Lot Erosion Control Plan - Type B

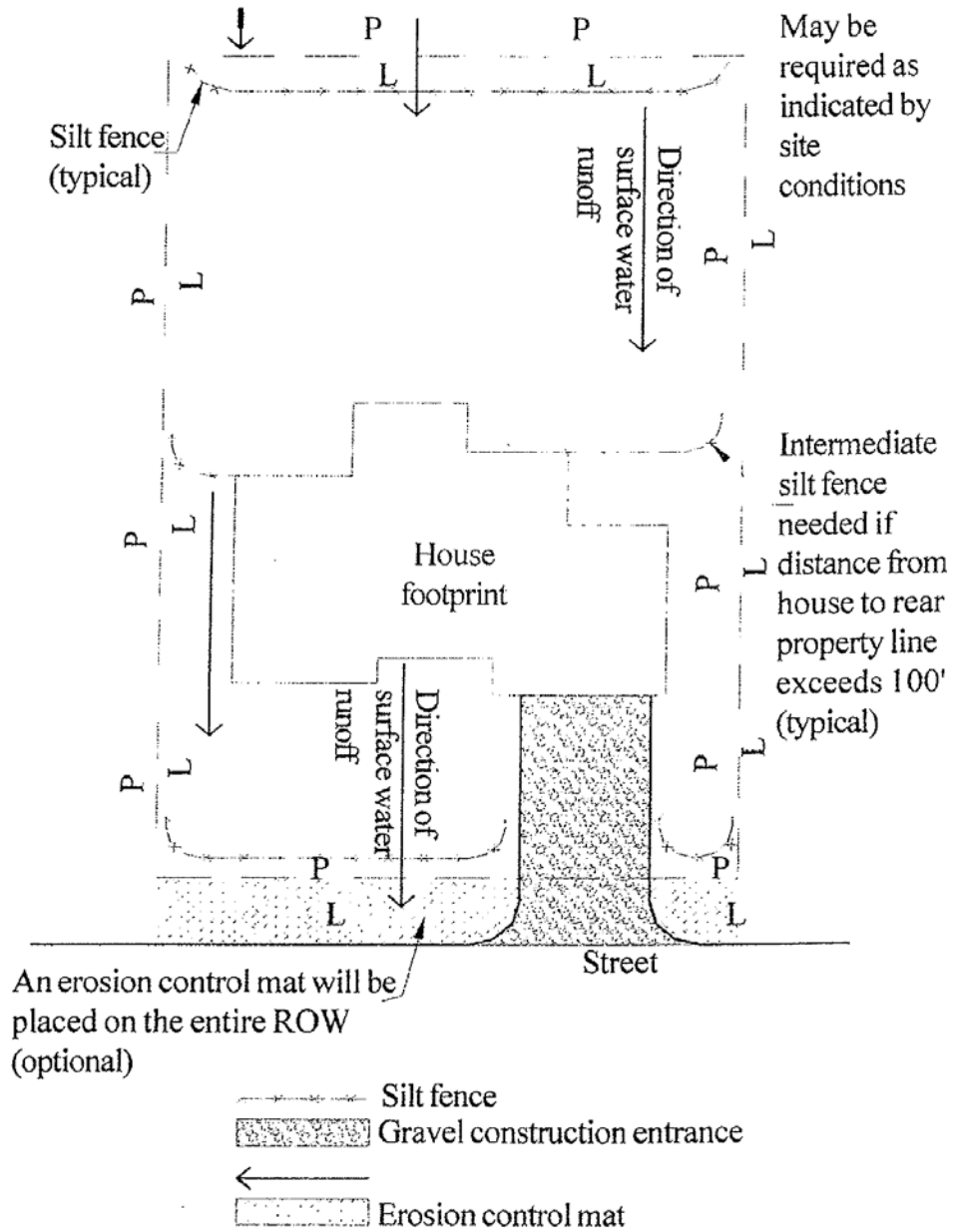

Single Family Lot Erosion Control Plan - Type C

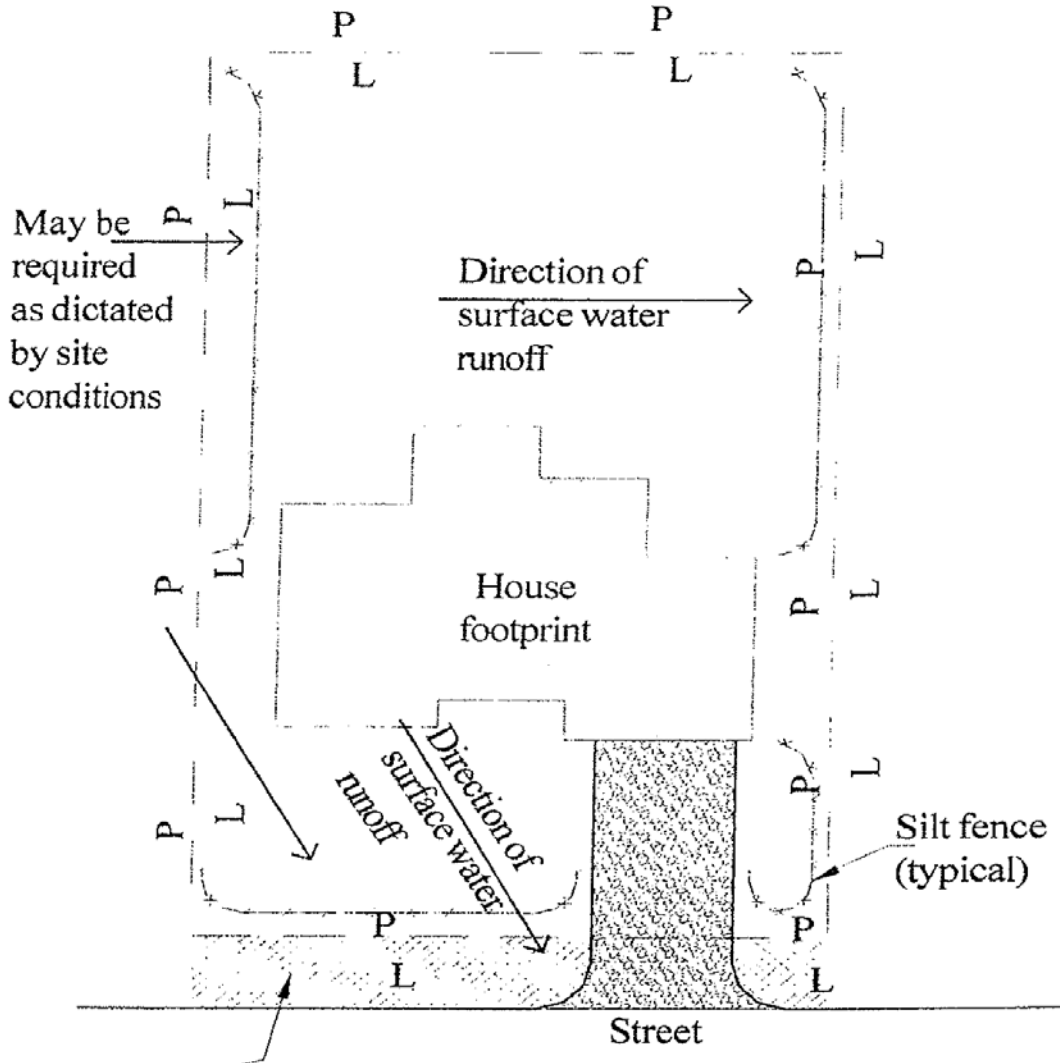

An erosion control mat will be placed on the entire ROW (optional)

- Silt fence
- Gravel construction entrance
- Direction of surface water runoff
- Erosion control mat

Curb Inlet Protection - Gravel Filter Bag

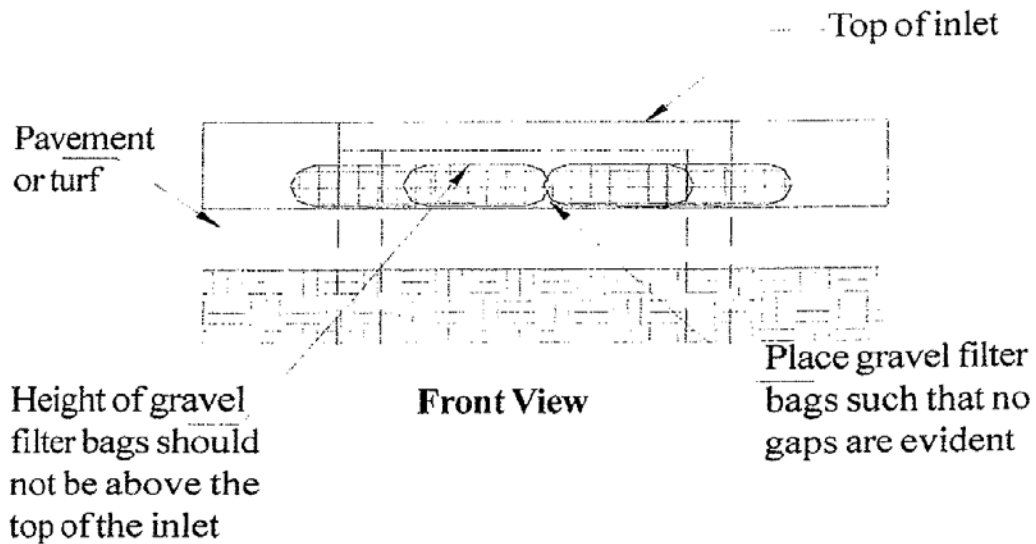
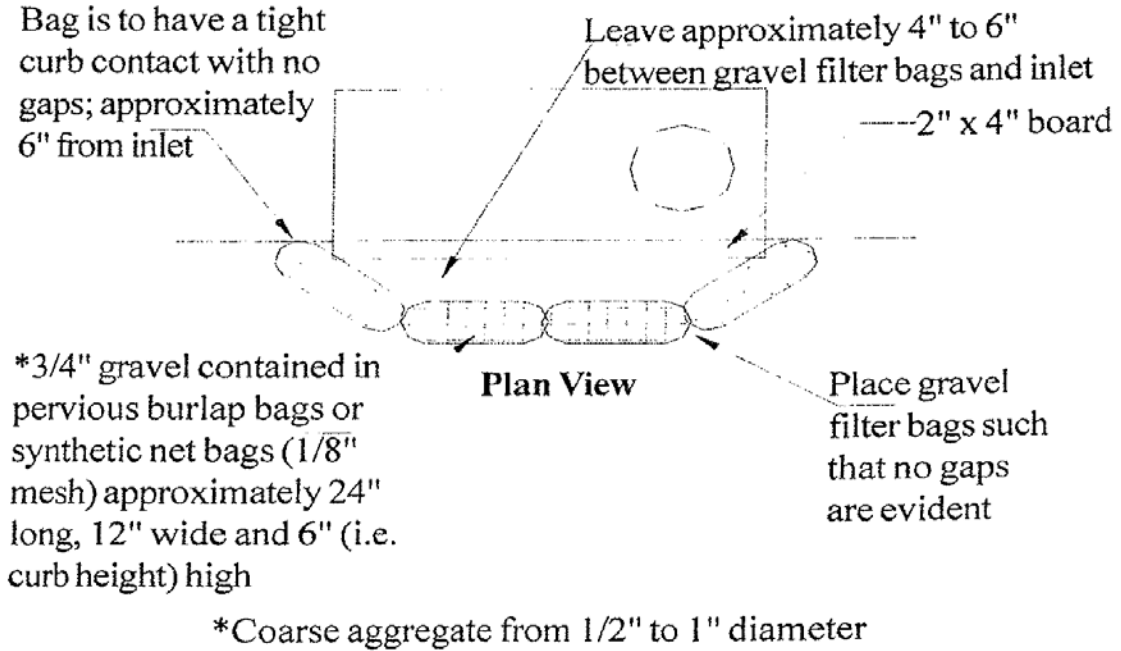

**Area Inlet Without
Installed Throat
and Top**

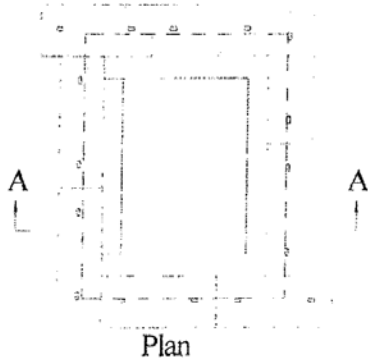

**Area Inlet With
Installed Throat
and Top**

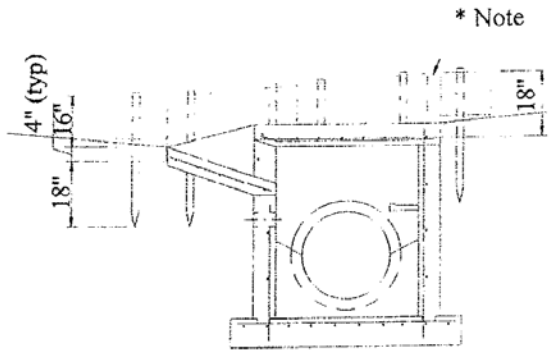
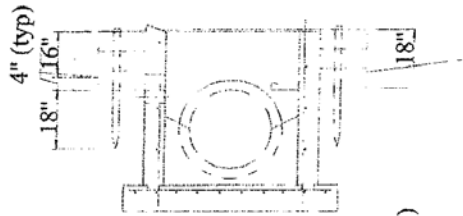
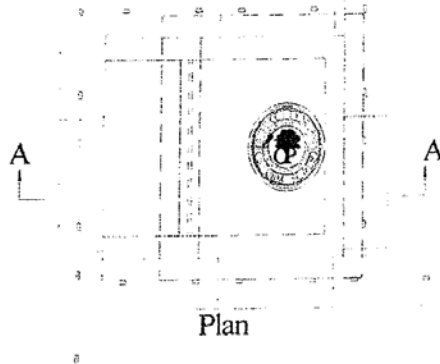

**Typical
Straw Bale**

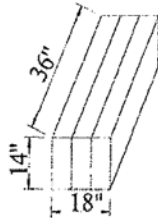

*Pack any voids between
bales with loose straw
allowing no gaps

Temporary Construction Entrance

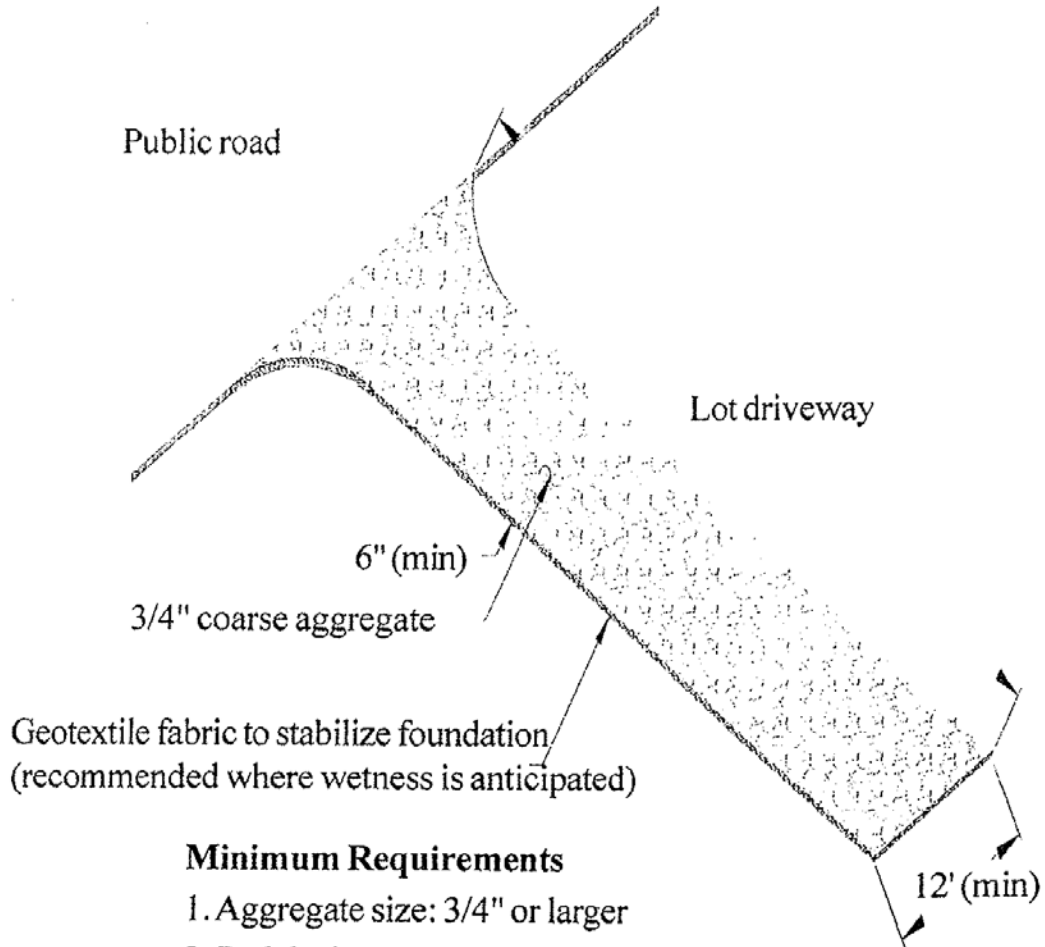

Minimum Requirements

1. Aggregate size: 3/4" or larger
2. Pad design-
Thickness: 6" minimum
Width: 12' minimum
Length: Lot driveway
3. Geotextile fabric-
an underliner of woven geotextile fabric may be used in wet conditions to provide stability

SEDIMENT FENCE Minimum Requirements

Length - maximum of 600', flare ends of fence uphill to temporarily impound water.

Spacing of support posts - 6' maximum.

Trench - bottom 1' of fence must be buried a minimum of 6" deep.

Impounded water height - depth of impounded water should not exceed 1.5' at any point along fence.

Support posts - 2" square wood or 1.0 lb/linear foot steel. Steel posts should have projections for fastening fabric.

Support wire - wire fence (14-gauge with 6" mesh), necessary if standard strength fabric is used.

Synthetic geo-textile fabric- conforming to specifications in Table 1 and containing ultraviolet light inhibitors and stabilizers. Minimum design life of 6 months.

Table 1

Specifications For Sediment Fence Fabric	
Physical Property	Minimum Requirement
Filtering Efficiency	85%
Tensile strength at 20% (maximum) elongation:	
Standard Strength =	30 lb/linear inch
High Strength =	50 lb/linear inch

FENCE INSTALLATION

Construction

- 1) Dig a trench at least 6" deep along the fence alignment.
- 2) Drive posts at least 18" into the ground on the down-slope side of the trench. Space posts a maximum of 6'.
- 3) Fasten support wire fence to upslope side of posts, extending 6" into trench.
- 4) Attach continuous length of fabric to upslope side of fence posts. Try to minimize the number of joints. Avoid joints at low points in the fence line. Where joints are necessary, fasten fabric securely to support posts and overlap to the next post.
- 5) Place the bottom 1" of fabric in the 6" deep trench (minimum), lapping toward the upslope side. Backfill with compacted earth or gravel.

Installation

Set posts and excavate a 6" x 6" (min) trench upslope along the line of posts

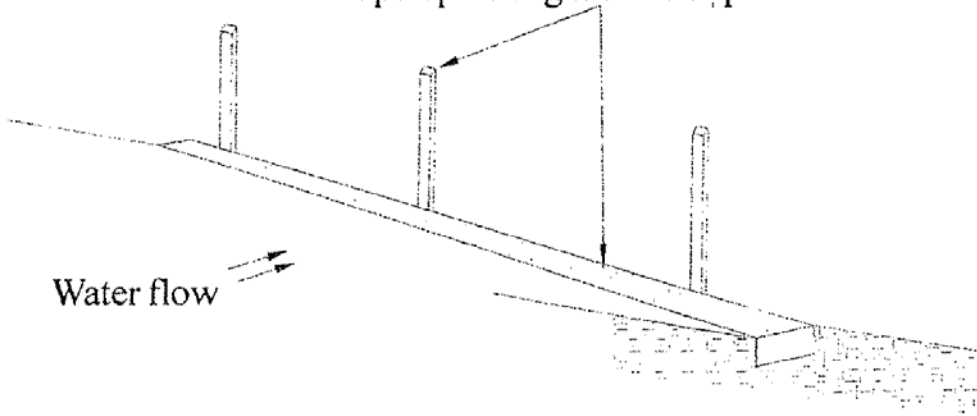

Extend fabric into the trench

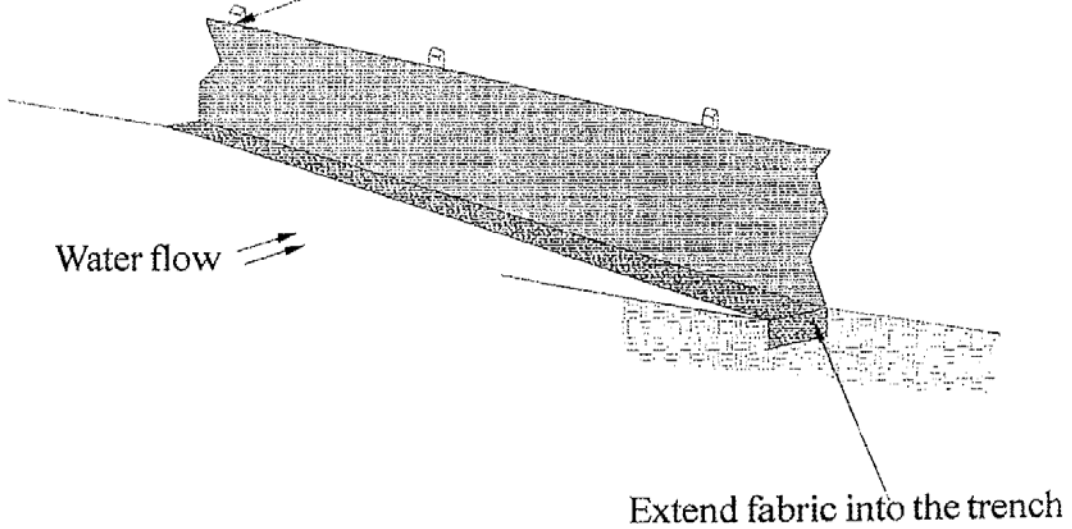

Installation (continued)

